

EXECUTIVE SUMMARY

The Martian Autonomous Rotary-wing Vehicle (MARV) is an autonomous rotorcraft (autonomous except for passive telemetry and course-correction aid from lander) for Martian exploration which has been designed in response to the American Helicopter Society's Seventeenth Annual Student Design Competition. The Request For Proposals (RFP) described the motivation for such an endeavor as being a natural extension of the use of robotic vehicles for planetary exploration. An autonomous rotorcraft, while a new concept for this purpose, would have several advantages over a conventional fixed-wing or ground-based vehicle. These include the ability to hover and fly slowly, allowing detailed imaging of terrain; the capability of soft landing and associated vehicle reuse; and having a greater range and speed than a ground-based rover.

Mission requirements and design objectives

The RFP specifies a number of required mission elements as part of the standard flight profile. Chief among these is the requirement that the rotorcraft maintain sustained controlled flight for a minimum of 30 minutes. Of secondary importance is the desire to have a range of at least 25 km. The overall strategy during the design process was to develop a vehicle that could carry the greatest possible payload within the weight limit of 50 kg specified in the RFP. The weight limit was interpreted as the maximum amount that NASA would be willing to carry (and pay for) and that the focus should thus be on carrying the highest payload possible. This resulted in a 50 kg vehicle which can carry 10.8 kg of payload over a range of 25 km.

Selection of coaxial configuration

Initial concept development resulted in a large number of different rotorcraft configurations. It was decided, in addition to the fundamental low Reynolds number issue which argued for as large a vehicle as possible, it would be best to develop a vehicle which could carry the maximum payload for the given take off weight. Initial studies conducted based on Boeing-Vertol methodology showed that the payload fraction remains nominally constant from a total vehicle take off mass of 20 kg to 50 kg. To have a substantial payload capability suitable for future sample return type missions, over a long range, it was decided that a vehicle gross weight of 50 kg would be most suitable. Hence a 50 kg vehicle take off mass maximizes both payload and payload fraction. The amount of payload that can be carried translates directly into the scientific utility of the vehicle, and because of the cost and rarity of such planetary exploration, this is what should be maximized in this design.

A coaxial configuration was chosen. The single-rotor/tail rotor configuration requires a long fuselage in order for the tail rotor to have a sufficiently long moment arm. Also a single rotor would require a higher rotor radius compared to a multi-rotor configuration. These factors made packaging of a single rotor inside the lander and subsequent deployment extremely complex. A coaxial, in contrast could generate the required amount of thrust for the smallest rotor disk area and needed no antitorque device. At the same time, it could be designed to achieve the blade Reynolds numbers necessary for efficient airfoil operation. The fuselage dimensions are no longer than required for payload and system packaging. Packaging inside the lander is compact and convenient. The quad rotor produced blade Reynolds numbers that appeared to be low for a reasonable overall vehicle size. In addition the complexity of having to power and control four separate rotors was deemed to be more than that of a coaxial. Above all, the coaxial is a mature and proven technology in contrast to quadrotors which are in the experimental stage. Thus the coaxial configuration appeared to be the most reliable configuration for Mars. For

proof of concept demonstration it was deemed essential to pick a configuration that not only appears to have higher payload capability but also one which can be used with maximum confidence. In terms of technological maturity and knowledge base, a coaxial far outweighs a quad rotor design.

Design features of the MARV

The MARV is an autonomous coaxial helicopter. The design is dominated by the unusual and often conflicting aerodynamic challenges of flight in the Martian atmosphere. Predicted size constraints inside the lander, as well as the stated weight limit of 50 kg, limit the physical size of the helicopter. Even with these challenges, the MARV has been carefully designed to achieve a maximum sustained flight for 30 minutes, having an associated range of 25 km. The MARV can then make a controlled landing on the Martian surface, and shortly thereafter perform another takeoff.

The rotors on the MARV seem to resemble turbine blades more than traditional helicopter main rotor blades. However, the blade planform stemmed from the unique aerodynamic concerns arising from operation in the Martian atmosphere, where the density of almost one one-hundredth that on Earth makes blade Reynolds numbers one or two orders of magnitude below those normally encountered on Earth, as well as lowering the speed of sound. Here are the highlights of the MARV design:

Specially designed airfoil meets the requirements of high lift at low Reynolds number and high subsonic Mach number, a combination of conditions that is rarely found on Earth.

Airfoil camber increases lifting capability. Low dynamic pressure ensures that the dimensional pitching moment is not high.

Low aspect ratio blades maximize blade Reynolds number while keeping the rotor diameter as small as possible. This produces a maximum blade Reynolds number of 78,000, and keeps the Reynolds number above 60,000 along more than half of the radius (below 50,000, it becomes extremely difficult to keep the boundary layer attached beyond the leading edge under any condition).

Taper is used to minimize induced power while still generating high Reynolds numbers on inboard portions of the blade.

Parabolic tip sweep keeps the incident Mach number at or below 0.5 along the entire blade, avoiding adverse compressibility effects, while allowing the rest of the blade to operate at conditions corresponding to an effectively higher Mach number.

Non-linear twist is used to produce the desired distribution of lift coefficient along the blade, avoiding sharp peaks or changes at any radial station.

Boundary layer trips are added on both the upper and lower surfaces to artificially transition the boundary layer to a turbulent state, energizing it and allowing it to stay attached for a much longer portion of the chord, as well as preventing the formation of a laminar separation bubble. Without such trips, at such low Reynolds numbers the laminar boundary layer separates before becoming turbulent, making re-attachment very difficult. Even if re-attachment does occur, a laminar separation bubble forms. As discussed above, trips may not work below Reynolds numbers of 50,000.

A coaxial configuration eliminates the need for a tail rotor and allows the rotor and fuselage to be as small as possible while still generating the required amount of thrust.

A conventional swashplate design is a proven effective means of control for coaxial rotors, whereas other methods have questionable effectiveness in such an environment.

An efficient electric motor minimizes powerplant weight and allows a high payload.

The rotor blades fold in two places, allowing **compact storage in the lander** during travel to Mars, minimizing the size requirement of the spacecraft. Special care is taken such that the **folded size matches the current dimensions of the Mars polar lander**. When on the Martian surface, the blades self-deploy and snap into place, keeping their extended position.

Retractable, lightweight composite landing legs provide the capability for a soft landing on the Martian surface after flight, avoiding damage to the vehicle and making another takeoff possible.

Innovative teetering hub design facilitates blade motions for load reduction as well as proper frequency placement to reduce vibration loads; a flexbeam hub design reduces **inplane vibration**; and **aeromechanic instabilities** are eliminated without the use of lag dampers.

Optimum rotor phasing based on trade-offs between low 2/rev g-levels and compactness of folding.

Detailed control system design with yaw stability scheme tailored for a two-bladed rotor.

Light weight transmission including bearings and gear teeth design.

State of the art **Proton Exchange Membrane (PEM) fuel cell powerplant**. Only pure hydrogen and pure oxygen used for power generation, producing no environmentally harmful byproducts.

Heaters provide insulation to protect avionics and subsystems from extreme low temperatures.

Fuselage shape allows placement of payload in locations that provide unobstructed views of the Martian landscape in flight.

Specially designed communication antennas to provide line of sight communication capability.

A full suite of **advanced navigation, communication, and scientific electronic equipment** makes the vehicle autonomous apart from passive telemetry.

Innovative integration of state of the art proven technology, with minimal reliance on future technology.

Download document

This document can be downloaded in PDF form from the following internet address:
<http://www.enaе.umd.edu/AGRC/Design00/MARV.html>

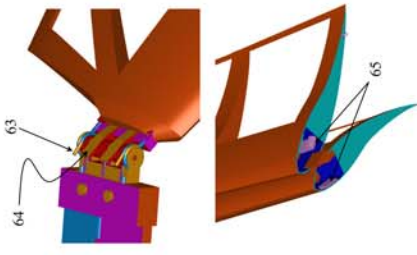

Blade Deployment Systems

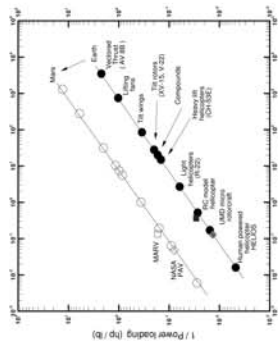

Design Space Envelope

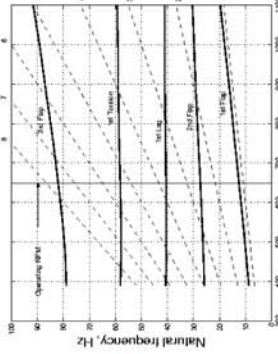

Rotor Frequency Plot

Performance at mission gross take off mass	Maximum cruise speed	11.5 m/s
	Maximum vertical rate of climb	2.5 m/s
	Range	25 km
	Endurance	39 minutes
Power plant	Average power output	4.63 kW
PEM Fuel cell stack	Maximum power output	6.43 kW
	Maximum take off mass	50 kg
	Payload	10.8 kg
	Rotor diameter	4266 mm
	Height from ground level	1510 mm
	Folded rotor diameter	1520 mm
	Height from ground level	1338 mm
	Inter rotor spacing	340 mm

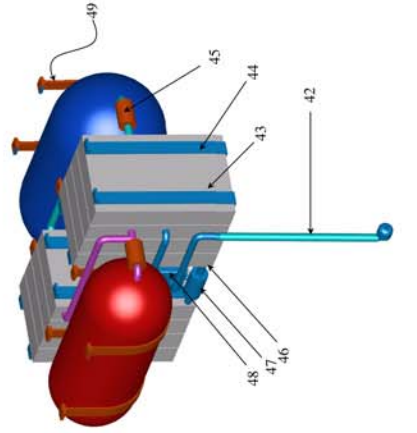

Fuel Cell System

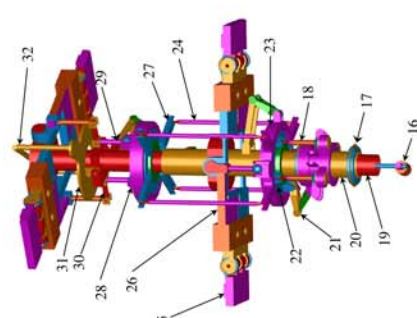
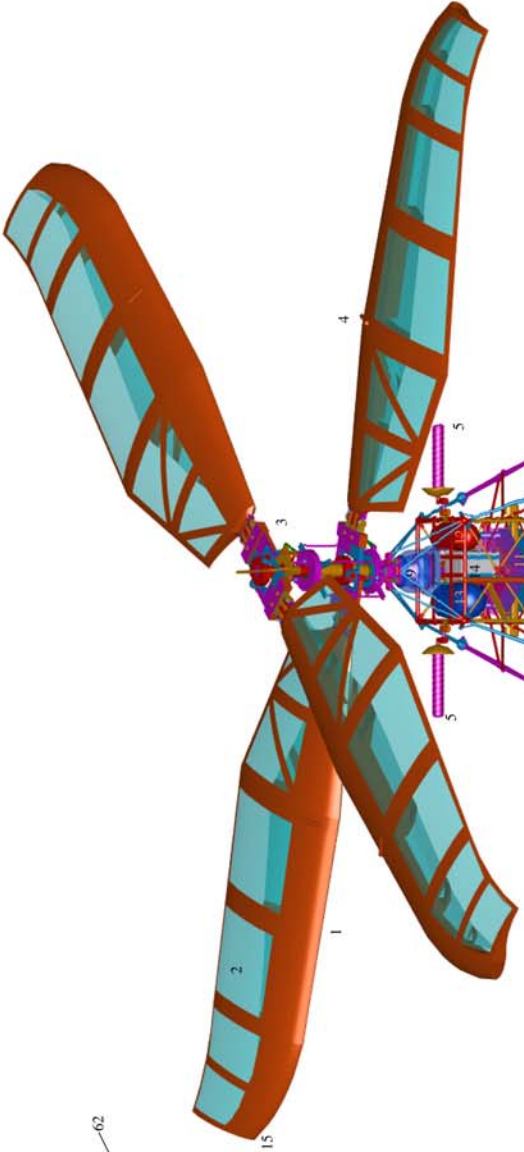

Hub and Control System

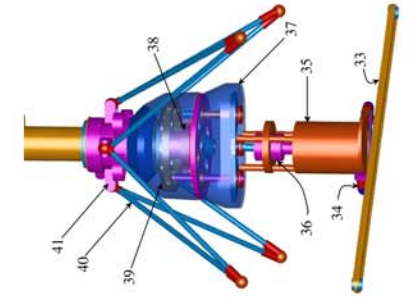

Transmission and Suspension

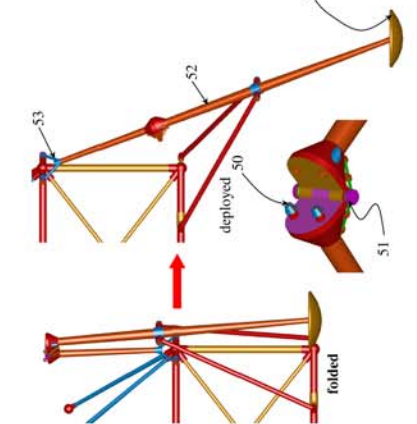

Landing Gear Deployment Linkages

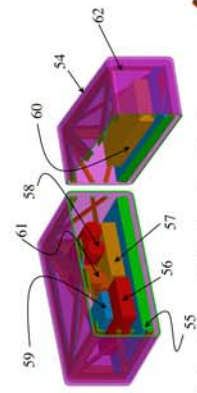

Avionics and Navigation Package

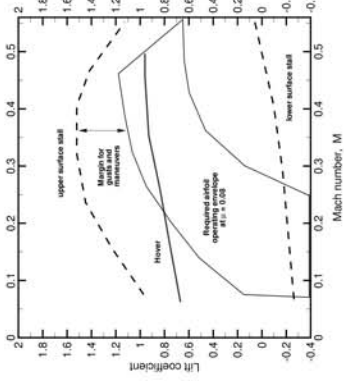

Operating Envelope

MARV, cutaway drawing key

- 1. Fully composite rotor blade
- 2. Ultrathin Mylar skin
- 3. Hub and control system (see detail)
- 4. Midspan blade deployment hinge
- 5. Directional UHF antennas and actuator
- 6. Landing gear foot pads
- 7. Secondary support studs
- 8. Landing gear deployment hinge(see detail)
- 9. Gearbox (see detail)
- 10. Main payload bay
- 11. Main avionics bay
- 12. Liquid O₂ tank
- 13. Liquid H₂ tank
- 14. Fuel cell system (see detail)
- 15. Swept tip for constant Mach number
- 16. Yaw actuator
- 17. Outer shaft lower bearing
- 18. Cyclic and collective actuators
- 19. Inner shaft
- 20. Outer shaft
- 21. Torque link
- 22. Non-rotating swashplate
- 23. Lower rotating swashplate
- 24. Swashplate links
- 25. Blade deployment hinge
- 26. Compact feathering door hinge
- 27. Upper control swashplate
- 28. Upper rotating swashplate
- 29. Pitch control link
- 30. Yaw fork link
- 31. Yaw actuation disk
- 32. Yaw control linkages
- 33. Motor torsion support
- 34. Elastomeric bushing
- 35. Aveox brushless DC motor
- 36. Clutch
- 37. Gearbox casing
- 38. Inner shaft spur gear
- 39. Outer shaft spur gear
- 40. Lift transfer links to fuselage
- 41. Fuselage attachment hard point
- 42. Heated water exhaust
- 43. Fuel cell stacks
- 44. Stack attachment
- 45. Fuel valve
- 46. Cell unit (8 modules)
- 47. Humidizer
- 48. Water reservoir
- 49. Tank attachment
- 50. Pawl latch
- 51. Torsion spring
- 52. Primary support strut
- 53. Hinged landing gear attachment
- 54. Aerogel insulation
- 55. Flight computer
- 56. Data multiplexer
- 57. Transceiver
- 58. Backup batteries
- 59. Computerized compass
- 60. Temperature sensor
- 61. Gyroscopes
- 62. Heated container
- 63. Deployment torsion spring
- 64. Positive hinge lock
- 65. Pawl locking mechanism

